



ROLL-OFF SERVICES

- Service Excellence
- Customer Focused
- Responsible Partners

Industrial and commercial customers with bulky, non-compactible materials such as construction waste, scrap steel, glass, concrete, pallets and wooden crates are best served by open-top roll-off container systems. We offer a full range of service options and equipment to efficiently and economically meet your waste collection needs.

The high-capacity steel boxes used in this waste collection system can be hand-fed, chute-fed or hopper-fed. Also, large rear doors can be opened to accommodate fork lifts for depositing extremely bulky or heavy materials. Full containers are replaced with empty ones on a pre-determined schedule or on an as-needed basis.

Allied Waste roll-off container systems let you safely and easily store waste as it accumulates. And since waste is stored in all-steel boxes, the risk of fire hazards is greatly reduced.

We maintain an inventory of roll-off containers in various sizes. Let our waste systems professionals recommend and design a system specifically tailored to meet your needs.

Proud to Keep America Clean

Service Excellence

At Allied Waste, we strive for service excellence. We have a team of experienced, highly-trained drivers and support staff. That means that your container will be placed exactly to your specifications and that you will be serviced safely, consistently and on-time.

Customer Focused

Building and maintaining customer relationships is central to our business. We are committed to providing best-in-class customer service. When you contact us, you will promptly reach an employee with a pleasing attitude who is ready to assist you.

Responsible Partners

Allied Waste is committed to providing outstanding service in a safe, efficient and cost-effective manner. Our goal is to ensure that you receive the ideal solid waste solution to meet your individual needs. We operate in strict compliance with all local, state and federal laws to enhance public safety and protect the environment.

Allied Waste is committed to providing superior service to all our customers. Our resources and know-how provide economical and responsible waste disposal solutions for your business.

An Allied Waste consultant will gladly discuss your waste collection needs with you and recommend a system tailored exactly to fit your needs. Call Allied Waste today. You'll find we have the experience and the capability to provide you with America's leading waste solutions.



ALLIED WASTE

www.disposal.com

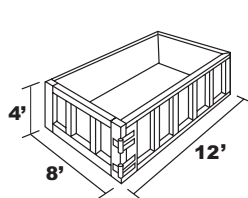
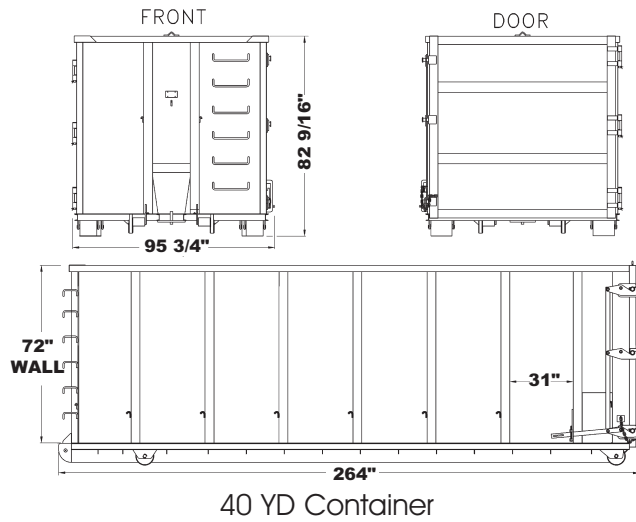
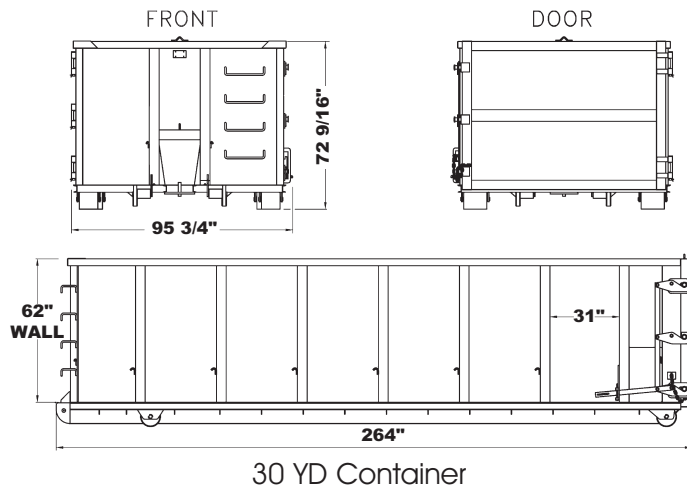

14 Cubic Yard Container

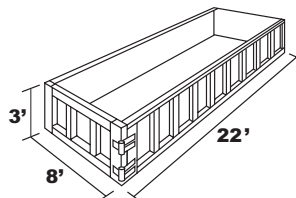

20 Cubic Yard Container

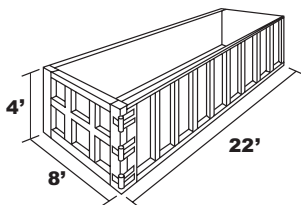

25 Cubic Yard Container

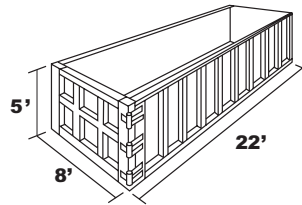

30 Cubic Yard Container

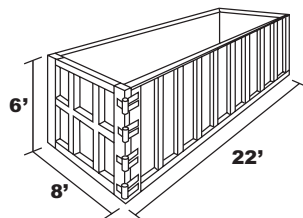

40 Cubic Yard Container

All measurements are approximate and sizes may vary by location.

Benefits of Allied Waste's Roll-Off Waste Services

Sanitary – all waste is kept in a single, open receptacle until it is collected by automated trucks.

Reduces fire hazard – depositing waste in an open all-steel container helps diminish the likelihood of accidental fires.

Saves labor – workers dump wastes into a large, conveniently located container...no bags to fuss with, no mess to clean up.

Aids pest control – with waste enclosed in a steel container, insects, rodents and other pests are less likely to be attracted.

Versatile – with containers available in a wide variety of sizes, Allied Waste can meet your every waste disposal need.

Conversion Table for Cubic Yard Volume (Approx.)

One cubic yard is equal to 27 cubic feet and approximately:

- 203 gallons
- Four 55-gallon drums
- Eleven 20-gallon cans
- Seven 30-gallon cans

Calculation:

To find container capacity in cubic yards:

$$\text{Formula: } \frac{L \times W \times H \text{ (ft)}}{27} = \text{Cubic Yards}$$

