



FRONT-END SERVICES

- Experienced, Trained Team
- Customer Focused
- Responsible Partners
- Flexible Service Programs



Allied Waste offers a full range of service options and equipment to efficiently and economically meet your waste collection needs. Front-end loader containers work best for businesses that generate low-density waste materials that can be compacted, such as office waste and food products. We maintain an inventory of containers in a variety of sizes and offer flexible collection scheduling. Let our waste services professionals recommend and design a waste collection system specifically tailored to meet your needs.

The versatile containers used in this waste collection system range from two to eight cubic yards and are often combined to give customers the right capacity for their waste volumes.

Many containers are designed with low-profile, top-loading configurations. Other containers open from both sides and from the top, as well. Special sizes and types of containers for unusual accumulation situations, easy rolling casters for mobility, and varying heights for dock-level loading are also available.

Front-end loader containers will not leak and are odor- and rodent-proof, provided the lid is kept closed. And since waste is stored in all-steel containers, the risk of fire hazards is reduced.

Proud to Keep America Clean

Experienced, Trained Team

Our team of experienced, highly-trained drivers and support staff provides efficient, timely service and safe operation. Our waste services experts can help you choose the right container system and advise you on understanding environmental and workplace regulations that affect your particular waste collection needs.

Customer Focused

Building and maintaining customer relationships is central to our business. We are committed to providing best-in-class customer service. When you contact us, you will promptly reach an employee with a pleasing attitude who is ready to assist you.

Responsible Partners

Allied Waste is committed to providing outstanding service in a safe, efficient and cost-effective manner. Our goal is to ensure that you receive the ideal solid waste solution to meet your individual needs. We operate in strict compliance with all local, state and federal laws to enhance public safety and protect the environment.

Flexible Service Programs

With our flexible scheduling, we can quickly respond to your changing waste collection needs. Our full range of well-maintained equipment and trained professionals assures you of the most cost-effective and reliable service available.

An Allied Waste consultant will gladly discuss your waste collection needs with you and recommend a system tailored exactly to fit your needs. Call Allied Waste today. You'll find we have the experience and the capability to provide you with America's leading waste service.

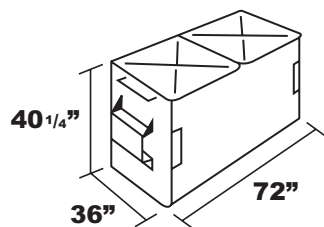

2 Cubic Yard Container

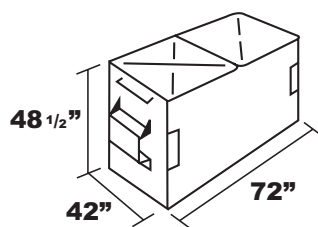

3 Cubic Yard Container

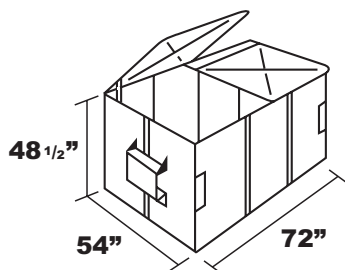

4 Cubic Yard Container

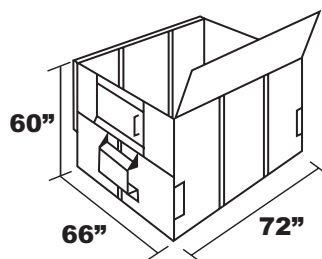

Low Top and Side Loading 6 Cubic Yard Container

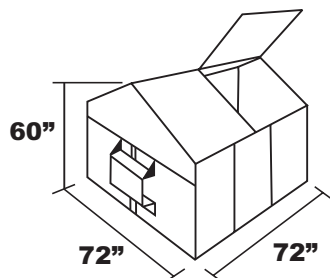

Slant 6 Cubic Yard Container

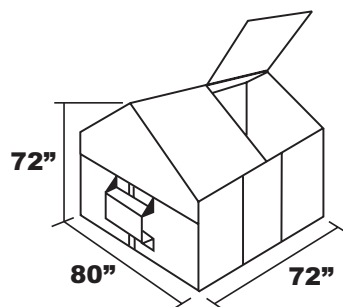

8 Cubic Yard Container

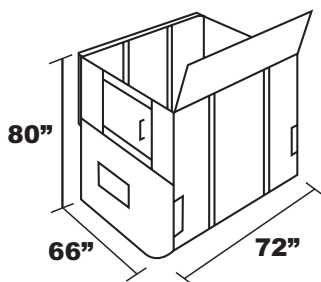

Top and Side Loading 8 Cubic Yard Container

Container designs and specifications may vary by location. Add 7" to the height if casters are installed.

Benefits of Allied Waste's Front-End Loader Waste Services

Sanitary – all waste is kept in a single, closed receptacle until it is collected by automated trucks.

Reduces fire hazard – depositing waste in a closed, all-steel container helps diminish the likelihood of accidental fires.

Saves labor – workers dump wastes into a large, conveniently located container...no bags to fuss with, no mess to clean up.

Aids pest control – with waste enclosed in a covered steel container, insects, rodents and other pests are less likely to be attracted.

Versatile – with containers available in a wide variety of sizes, Allied Waste can meet your every waste disposal need.

